

acoustic®

B200, B200H, B410, B115, B600H, B810 USER'S MANUAL

200 WATT COMBO, 200 WATT HEAD, 410 CABINET,
115 CABINET, 600 WATT HEAD, 810 CABINET





THREE (3) YEAR LIMITED WARRANTY

Subject to the limitations set forth below, Acoustic® hereby represents and warrants that the components of this product shall be free from defects in workmanship and materials, including implied warranties of merchantability or fitness for a particular purpose, subject to normal use and service, for three (3) years to the original owner from the date of purchase.

Retailer and manufacturer shall not be liable for damages based upon inconvenience, loss of use of product, loss of time, interrupted operation or commercial loss or any other incidental or consequential damages, including but not limited to, lost profits, downtime, goodwill, damage to or replacement of equipment and property, and any costs of recovering, reprogramming, or reproducing any program or data stored in equipment that is used with Acoustic® products. This guarantee gives you specific legal rights. You may have other legal rights which vary from state to state. Some states do not allow limitations on how long an implied warranty lasts, so the above limitation may not apply to you.

FCC Statements

1. **Caution:** Changes or modifications to this unit not expressly approved by the party responsible for compliance could void the user's authority to operate the equipment.
2. **Note:** This equipment has been tested and found to comply with the limits for a Class B digital device, pursuant to Part 15 of the FCC Rules. These limits are designed to provide reasonable protection against harmful interference in a residential installation. This equipment generates, uses, and can radiate radio frequency energy and, if not installed and used in accordance with the instructions, may cause harmful interference to radio communications. However, there is no guarantee that interference will not occur in a particular installation. If this equipment does cause harmful interference to radio or television reception, which can be determined by turning the equipment off and on, the user is encouraged to try to correct the interference by one or more of the following measures:
 - Reorient or relocate the receiving antenna.
 - Increase the separation between the equipment and receiver.
 - Connect the equipment into an outlet on a circuit different from that to which the receiver is connected.
 - Consult the dealer or an experienced radio/TV technician for help.

California Prop 65 Warning

This product may contain a chemical(s) known to the state of California to cause cancer or birth defects or other reproductive harm.

Acoustic
13659 Victory Blvd. # 1-360
Van Nuys, CA 91407

All trademarks and registered trademarks mentioned herein are recognized as the property of their respective holders.
0808-8192

IMPORTANT SAFETY INSTRUCTIONS

EXPOSURE TO HIGH NOISE LEVELS MAY CAUSE PERMANENT HEARING LOSS. INDIVIDUALS VARY CONSIDERABLY TO NOISE-INDUCED HEARING LOSS BUT NEARLY EVERYONE WILL LOSE SOME HEARING IF EXPOSED TO SUFFICIENTLY INTENSE NOISE OVER TIME.

The U.S. Government's Occupational Safety and Health Administration (OSHA) has specified the following permissible noise level exposures:

DURATION PER DAY (HOURS)	8	6	4	3	2	1	1/2hr. or less
SOUND LEVEL (dB)	90	93	95	97	100	103	110



This symbol is intended to alert the user to the presence of non-insulated dangerous voltage within the product's enclosure.



This symbol is intended to alert the user to the presence of important operating and maintenance (servicing) instructions in the literature accompanying the unit.



Apparatus shall not be exposed to dripping or splashing. Objects filled with liquids, such as vases, shall not be placed on the apparatus.

CAUTION
RISK OF ELECTRIC SHOCK
DO NOT OPEN

CAUTION: TO REDUCE THE RISK OF ELECTRIC SHOCK, DO NOT REMOVE CHASSIS. NO USER-SERVICEABLE PARTS INSIDE. REFER SERVICING TO QUALIFIED SERVICE PERSONNEL.

According to OSHA, any exposure in the above permissible limits could result in some hearing loss. Hearing protection must be worn when operating this amplification system in order to prevent permanent hearing loss.

1. Read all safety and operating instructions before using this product.
2. All safety and operating instructions should be kept for future reference.
3. Read and understand all warnings listed on the operating instructions.
4. Follow all operating instructions to operate this product.
5. This product should not be used near water, i.e., a bathtub, sink, swimming pool, wet basement, etc.
6. Only use a dry cloth to clean this product.
7. Do not block any ventilation openings. The product should not be placed flat against a wall or placed in a built-in enclosure that will impede the flow of cooling air.
8. Do not install this product near any heat source such as radiators, heat registers, stoves or other apparatuses (including amplifiers) that produce heat.
9. Do not defeat the safety purpose of the polarized or grounding-type plug. A polarized plug has two blades – with one wider than the other. A grounding-type plug has two blades and a third grounding prong. The wide blade or the third prong is provided for your safety. If the provided plug does not fit into your outlet, consult an electrician for replacement of the obsolete outlet.
10. Protect the power cord from being walked on or pinched, particularly at plugs, convenience receptacles, and the point where it exits from the apparatus. Do not break the ground pin of the power supply cord.
11. Only use attachments specified by the manufacturer.
12. Use only with the cart, stand, tripod, bracket, or table specified by the manufacturer or sold with the apparatus. When a cart is used, exercise caution when moving.
13. Unplug this apparatus during lightning storms or when unused for a long period of time.
14. Care should be taken so that objects do not fall and liquids are not spilled into the unit through the ventilation ports or any other openings.
15. Refer all servicing to qualified service personnel. Servicing is required when the apparatus has been damaged in any way.
16. WARNING: To reduce the risk of fire or electric shock, do not expose this apparatus to rain or moisture.
17. When a mains plug or an appliance coupler is used as the disconnect device, the disconnect device shall remain readily operable.



acoustic®

CONGRATULATIONS

Congratulations on your purchase of an Acoustic product. Founded as the Acoustic Control Corporation in Van Nuys, California in 1969, Acoustic is the rig of choice for many legendary touring professionals. Acoustic amp users include some of music's premier rock, jazz and funk bassists — and many of the original Acoustic rigs are still cranking out massive tone on stages world wide.

Now you own a piece of the Acoustic legacy — so turn it up and enjoy what pros have known about for years. Welcome to Acoustic, the Pro's Tone™.

OUR MISSION

The Acoustic design philosophy is simple: Create a line of amps that are simple to operate and simple to maintain, with Fast-Tone™ technology that allows you to dial up great sound in an instant. This way of thinking is part of every amp we make. That's why many legendary bassists have used Acoustic to develop their trademark sounds.

If you're new to Acoustic amps, we encourage you to get in tune with their rich heritage and join the long line of Acoustic users and endorsers who would never consider playing through anything else.



TABLE OF CONTENTS

THREE (3) YEAR LIMITED WARRANTY.....	2
IMPORTANT SAFETY INSTRUCTIONS.....	3
CONGRATULATIONS / OUR MISSION.....	4
TAKING CARE OF YOUR BASS AMPLIFIER.....	6
PANEL CONFIGURATIONS.....	7-10
FRONT PANEL LAYOUT.....	7 - 8
REAR PANEL LAYOUT.....	8 - 9
REAR JACK PLATE.....	10
PRODUCT SPECIFICATIONS.....	10
SUGGESTED TONE SETTINGS.....	11
FEATURES.....	12-13
SIGNAL FLOW DIAGRAMS.....	14-15



TAKING CARE OF YOUR BASS AMPLIFIER

LOCATION

- To avoid deformation, discoloration, or more serious damage, do not expose the unit to direct sunlight, high temperature sources, or excessive humidity.

POWER SUPPLY

- Turn the power switch off when the Amplifier is not in use.
- The Amplifier (main plug) should be unplugged from the AC outlet if the Amplifier will not be used for an extended period of time.
- Avoid plugging the Amplifier (main plug) into an AC outlet that is also powering high-consumption appliances such as electric heaters or televisions. Also avoid using multi plug adapters since these can reduce sound quality, cause operation errors, and result in possible damage.
- To avoid damage, turn off the Amplifier power switch and all related devices prior to connecting or disconnecting cables.

HANDLING AND TRANSPORT

- Never apply excessive force to any parts.
- Unplug cables by gripping plugs firmly. Do not pull on cables.
- Physical shocks caused by dropping or bumping the product can result in serious damage.

CLEANING

- Clean with a dry, soft cloth.
- A slightly damp cloth may be used to remove stubborn grime and dirt.
- Never use cleaners such as alcohol or thinner.

ELECTRICAL INTERFERENCE

- The Amplifier contains electronic circuitry that may cause interference if placed too close to radio or television receivers. If this occurs, move the Amplifier further away from the affected equipment.

SERVICE AND MODIFICATION

- There are no user serviceable parts in any units covered in this manual.
- Do not attempt to open the units or make any change to circuits or parts. This will void the warranty.

PANEL CONFIGURATION

FRONT PANEL LAYOUT

B200

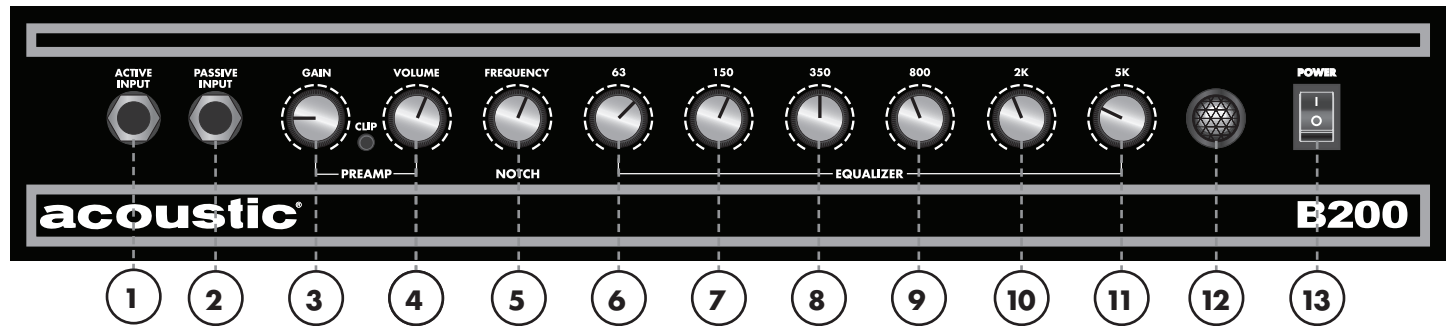

1. 1/4" Active input – use for bass guitars with active pickups. This input is -10dB from the passive input.
2. 1/4" Passive input – use for bass guitars with passive pickups.
3. Gain control – set so clip indicator does not light, otherwise distortion may occur.
4. Volume level control – set to your desired volume level. If distortion occurs, reduce volume level.
5. Active -10 dB notch at frequencies from 50Hz to 1kHz – approximately 250Hz with the frequency knob at 12 o'clock.
6. Active low frequency control – set to boost (+12 dB) or cut (-12 dB) frequencies centered around 63 Hz.
7. Active low-mid frequency control – set to boost (+12 dB) or cut (-12 dB) frequencies centered around 150 Hz.
8. Active low-mid frequency control – set to boost (+12 dB) or cut (-12 dB) frequencies centered around 350 Hz.
9. Active high-mid frequency control – set to boost (+12 dB) or cut (-12 dB) frequencies centered around 800 Hz.
10. Active high frequency control – set to boost (+12 dB) or cut (-12 dB) frequencies centered around 2 kHz.
11. Active high frequency control – set to boost (+12 dB) or cut (-12 dB) frequencies set centered around 5 kHz.
12. On/Off light - when this jewel light is lit, your amp is on and ready to be played.
13. Power switch - turns amp on or off.

acoustic®

B600H

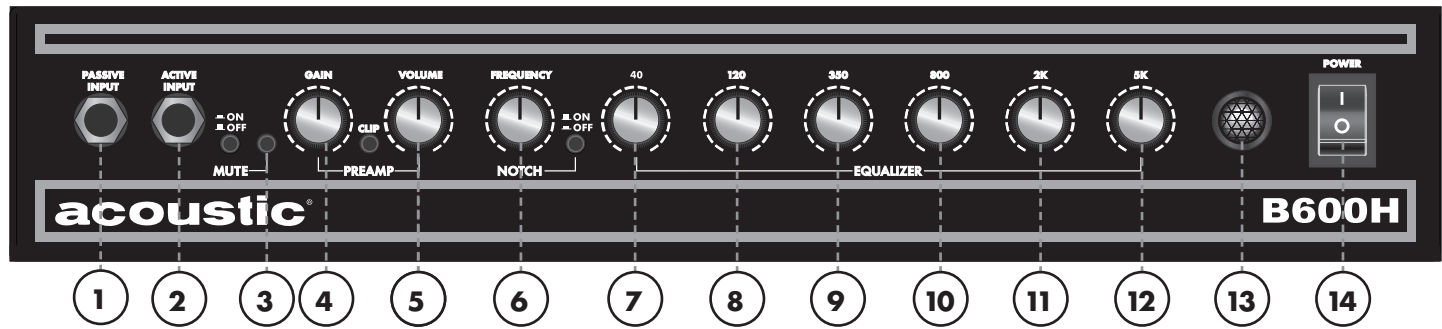

1. 1/4" Passive input – use for bass guitars with passive pickups.
2. 1/4" Active input – use for bass guitars with active pickups. This input is -10dB from the passive input.
3. Mute switch – push button in to activate mute circuit. The red light will come on.
4. Gain control – set so clip indicator is not lit, otherwise distortion may occur.
5. Volume level control – set to your desired volume level. If distortion occurs, reduce volume level.
6. Active -10 dB notch at frequencies from 50Hz to 1kHz - approximately 250Hz with the frequency knob at 12 o'clock. Notch on/off switch is foot-switchable.
7. Active low frequency control – set to boost (+12 dB) or cut (-12 dB) frequencies centered around 63 Hz.
8. Active low-mid frequency control – set to boost (+12 dB) or cut (-12 dB) frequencies centered around 150 Hz.
9. Active low-mid control – set to boost (+12 dB) or cut (-12 dB) frequencies centered around 350 Hz.
10. Active high-mid control – set to boost (+12 dB) or cut (-12 dB) frequencies centered around 800 Hz.
11. Active high frequency control – set to boost (+12 dB) or cut (-12 dB) frequencies centered around 2 kHz.
12. Active high frequency control – set to boost (+12 dB) or cut (-12 dB) frequencies set centered around 5 kHz.
13. On/Off light - when this jewel light is lit, your amp is on and ready to be played.
14. Power switch - turns amp on or off.

REAR PANEL LAYOUT

B200H

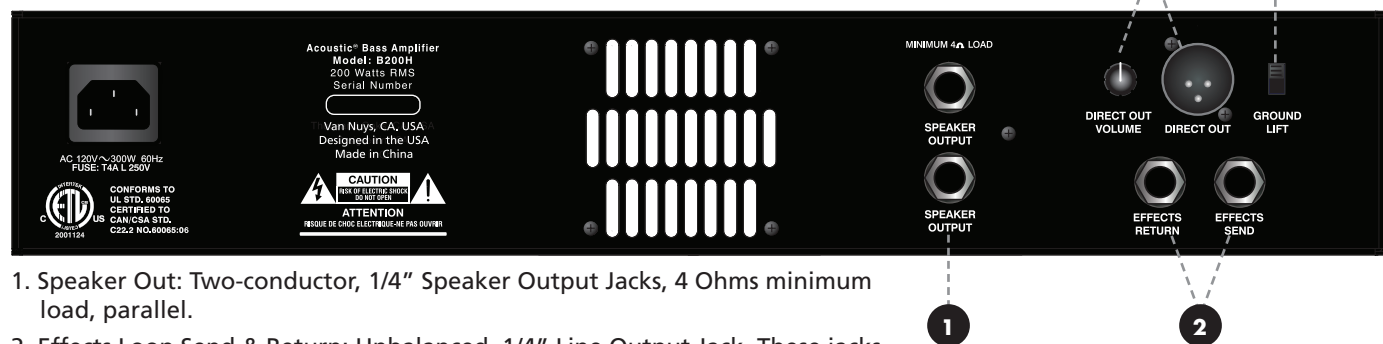

1. Speaker Out: Two-conductor, 1/4" Speaker Output Jacks, 4 Ohms minimum load, parallel.
2. Effects Loop Send & Return: Unbalanced, 1/4" Line Output Jack. These jacks will allow a signal to be sent to an external effects device or equalizer, then patched back in before the power amp section.
3. Direct Out with Volume Control: This sends a line-level signal to a PA system or recording device. Use the Direct Out Volume knob to prevent clipping.
4. Ground Lift Switch: Lifts ground on pin 1 on XLR.

B200, B200H, B410, B115, B600H, B810

USER'S MANUAL

200 WATT COMBO, 200 WATT HEAD, 410 CABINET,
115 CABINET, 600 WATT HEAD, 810 CABINET

B200

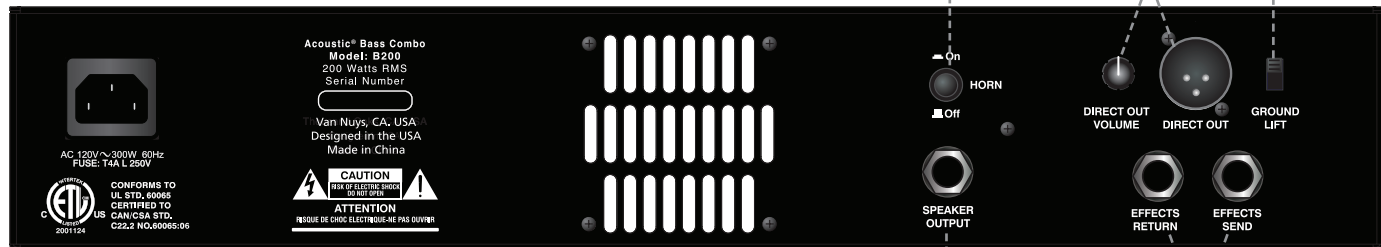

1. Speaker Out: Two-conductor, 1/4" Speaker Output Jacks, 4 Ohms minimum load, parallel.
2. Effects Loop Send & Return: Unbalanced, 1/4" Line Output Jack. These jacks will allow a signal to be sent to an external effects device or equalizer, then patched back in before the power amp section.
3. Horn Switch: Press in to toggle horn on or off.
4. Direct Out with Volume Control: This sends a line-level signal to a PA system or recording device. Use the Direct Out Volume knob to prevent clipping.
5. Ground Lift Switch: Lifts ground on pin 1 on XLR.

B600H

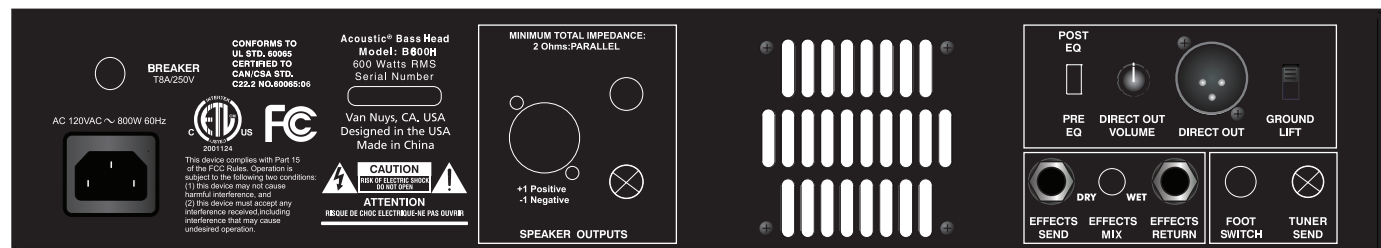

1. Speaker Out: Two-conductor, 1/4" Speaker Output Jacks, 2 Ohms minimum load, parallel.
2. Effects Loop Send & Return: Unbalanced, 1/4" Line Output Jack. These jacks will allow a signal to be sent to an external effects device or equalizer, then patched back in before the power amp section.
3. Direct Out with Volume Control: This sends a line-level signal to a PA system or recording device. Use the Direct Out Volume knob to prevent clipping.
4. Ground Lift Switch: Lifts ground on pin 1 on XLR.

REAR JACK PLATE

B410 & B115

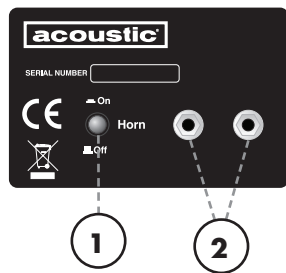

1. Horn On/Off Switch.
Push in to activate horn.
2. Input Jacks. 8 Ohm impedance.
B410 Power Handling: 400 Watts RMS
B115 Power Handling: 250 Watts RMS
Jacks are wired in parallel.

B810



1. Horn On/Off Switch.
Push in to activate horn.
2. Input Jacks. 4 Ohm impedance.
B810 Power Handling: 800 Watts RMS
Jacks are wired in parallel.

PRODUCT SPECIFICATIONS

MODEL:	B200	B200H	B600H
POWER:	200 Watts @ 4 Ohms	200 Watts @ 4 Ohms	600 Watts @ 2 Ohms 450 Watts @ 4 Ohms
EQUALIZER:	6-Band w/Notch	6-Band w/Notch	6-Band w/Notch
SPEAKER:	15"	-	-
DIMENSIONS:	24.75"H x 20"W x 15"D	5.25"H x 20"W x 11"D	8.75"H x 23.6"W x 17.32"D
WEIGHT:	67 lb.	23 lb.	33.1 lb.
MODEL:	B410	B115	B810
POWER:	400 Watts (8 Ohms)	250 Watts (8 Ohms)	800 Watts (4 Ohms)
EQUALIZER:	-	-	-
SPEAKER:	10" (x 4)	15"	10" (x 8)
DIMENSIONS:	24"H x 25"W x 16"D	24"H x 25"W x 16"D	52.67"H x 28.5"W x 20"D
WEIGHT:	73 lb.	63 lb.	143 lb.

SUGGESTED TONE SETTINGS

= Setting Range

The following setting suggestions will help you find your signature tone. They are designed to get you close to the sound you are looking for. You take it from there.

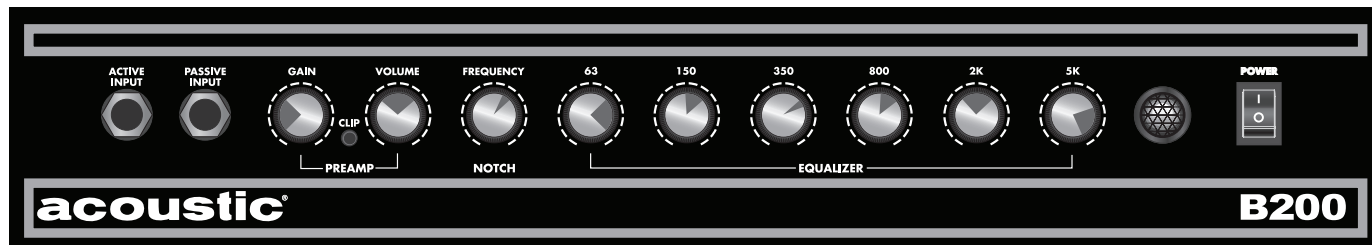

TRADITIONAL ELECTRIC BASS SETTING - In this setting, the amplifier will deliver a standard electric bass sound. Whether you are playing rock, country, blues or gospel, this setting will get you close. If you play with a pick and want less top end attack on the notes, roll off a bit of the high frequency control. If it's a deeper bottom you're looking for, add more low and low-midrange frequencies. The key to achieving your own personal sound is experimentation.

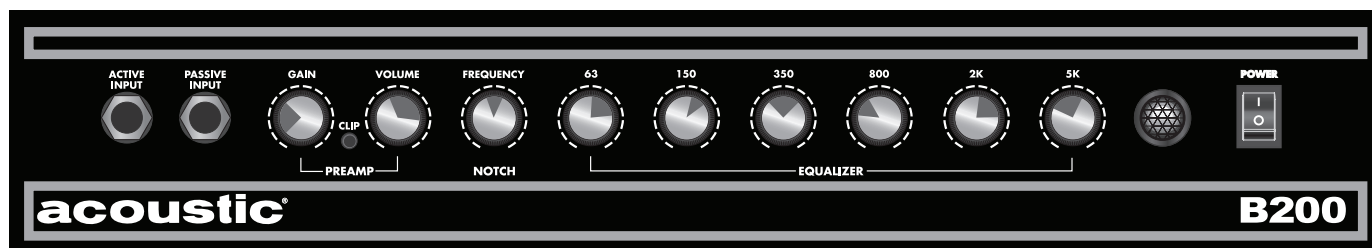

FUNK "SLAP" SOUND - This style of music needs a strong attack with lots of top end. Usually a hollowed out middle will produce the extra top end necessary for this style of music. If you are using a "thumb" style, add a bit more low end and extra volume – or less if you really hit it hard.

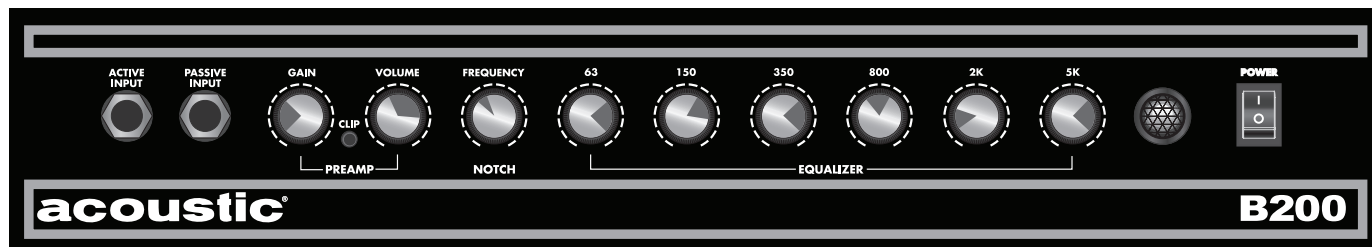

ALTERNATIVE STYLE - This setting is designed for an upper end punch and edge that will cut through most any sound. This style will work well with pick or fingers and will add a touch of distortion to the sound as well. Make sure your instrument's volume control is up all the way. Since you are adding volume, you need to be careful with the actual amount of E.Q. you use as it can also add distortion to the sound. As in all the settings above, it is strictly a matter of personal taste in achieving the sound you are looking for, so experiment.

FEATURES

B200H



1. Rugged & Comfortable Handle
2. Protective, Long-Lasting Vinyl Tolex Cover
3. Easy to Read Control Panel
4. Power Switch

B200

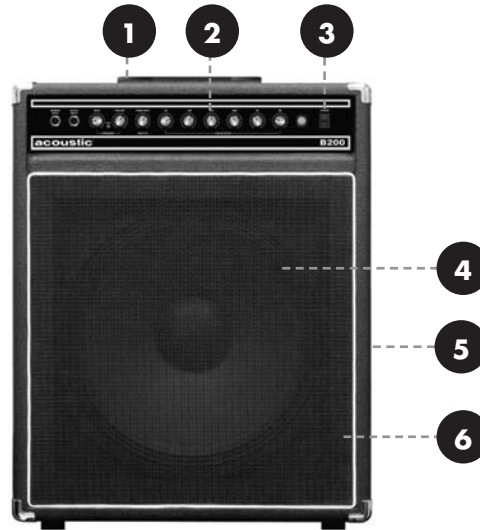

1. Rugged & Comfortable Handle
2. Easy to Read Control Panel
3. Power Switch
4. Heavy-Duty Woofer for Enhanced Bass Response
5. Protective, Long-Lasting Vinyl Tolex Cover
6. Heavy-Weight Cloth Grill

B115

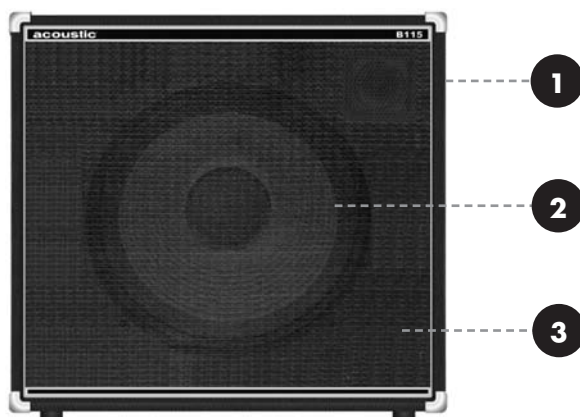

1. Protective, Long-Lasting Vinyl Tolex Cover
2. Heavy-Duty Woofer for Enhanced Bass Response
3. Heavy-Weight Cloth Grill

B410

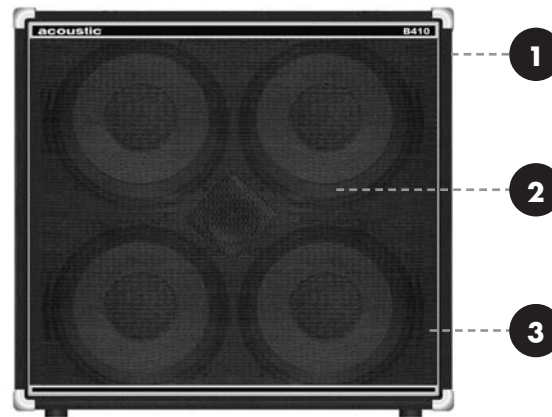

1. Protective, Long-Lasting Vinyl Tolex Cover
2. Heavy-Duty Woofer for Enhanced Bass Response
3. Heavy-Weight Cloth Grill

B600H

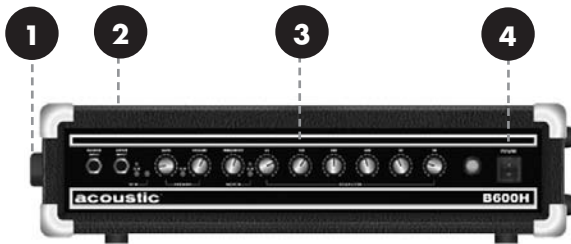

1. Rugged & Comfortable Handle
2. Protective, Long-Lasting Vinyl Tolex Cover
3. Easy to Read Control Panel
4. Power Switch

B810

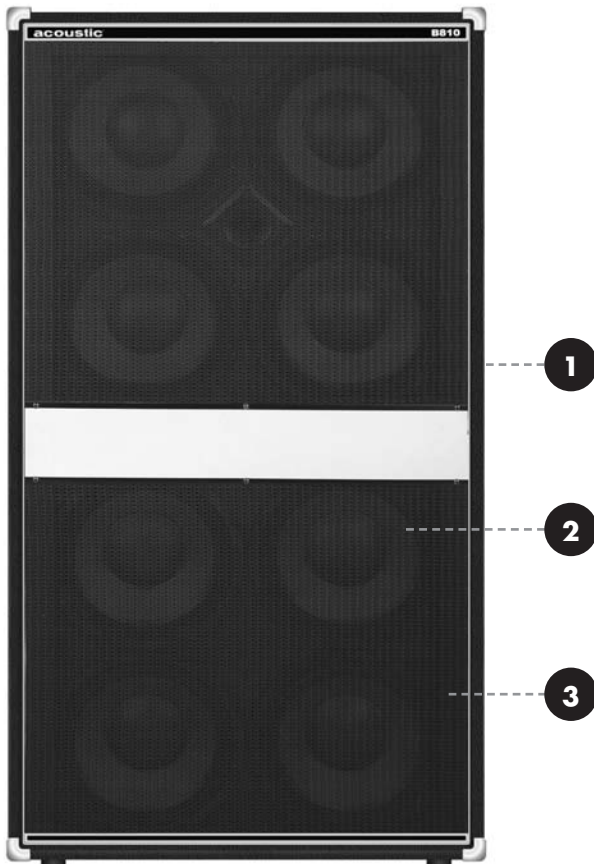

1. Protective, Long-Lasting Cover
2. Heavy-Duty Woofer for Enhanced Bass Response
3. Heavy-Weight Cloth Grill

SIGNAL FLOW DIAGRAMS

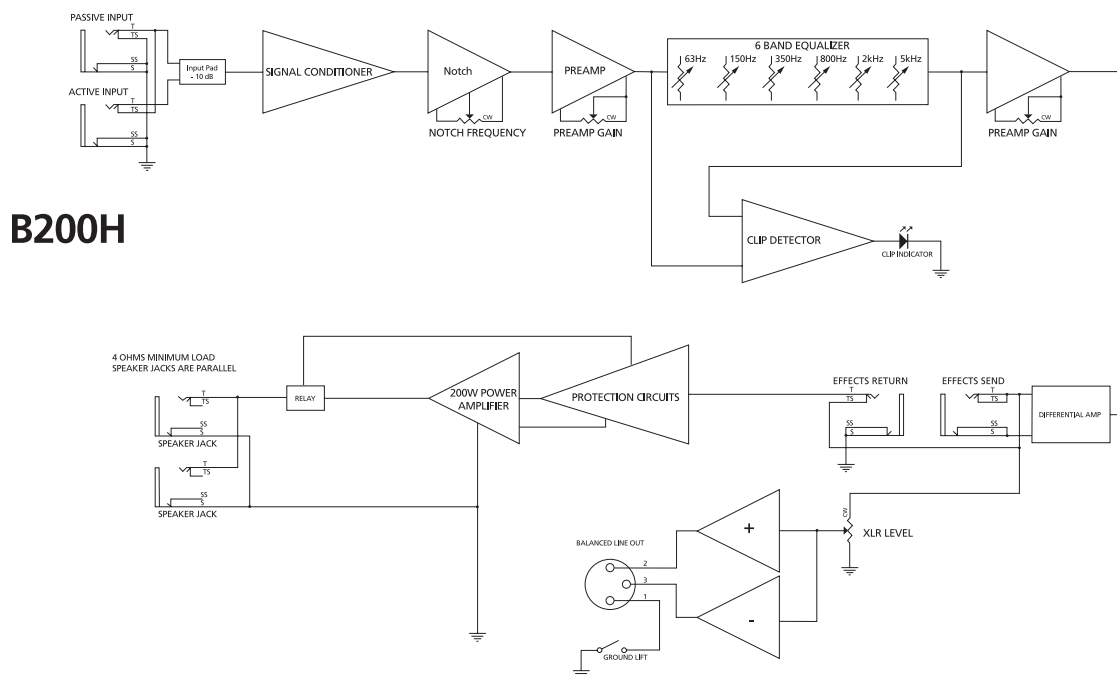
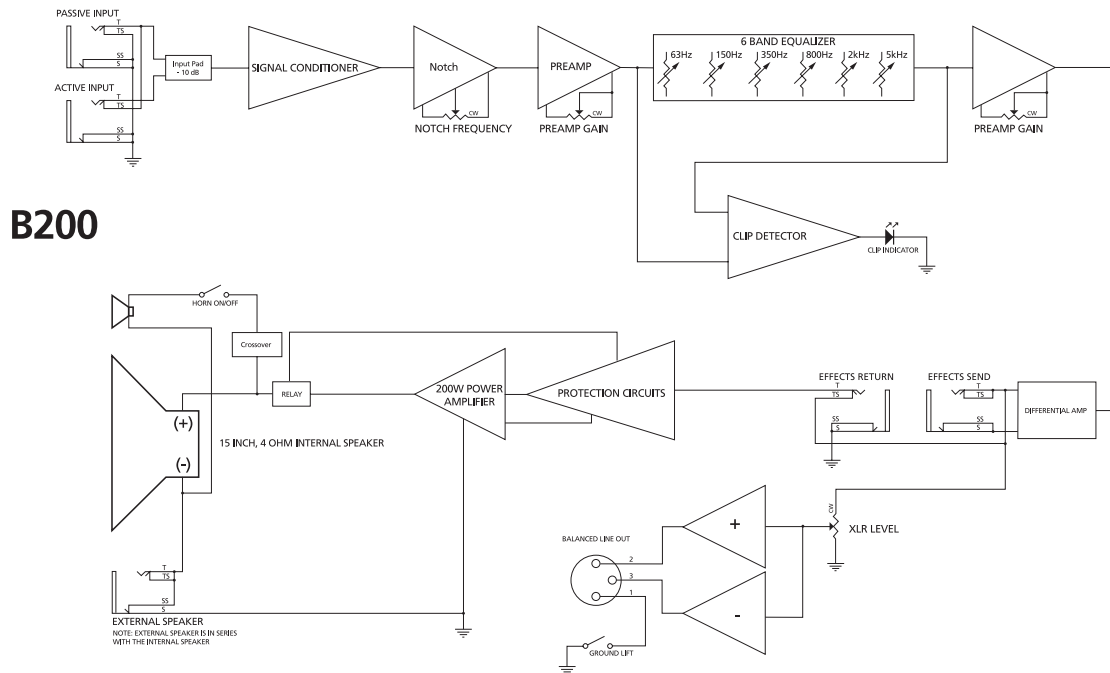

B600H

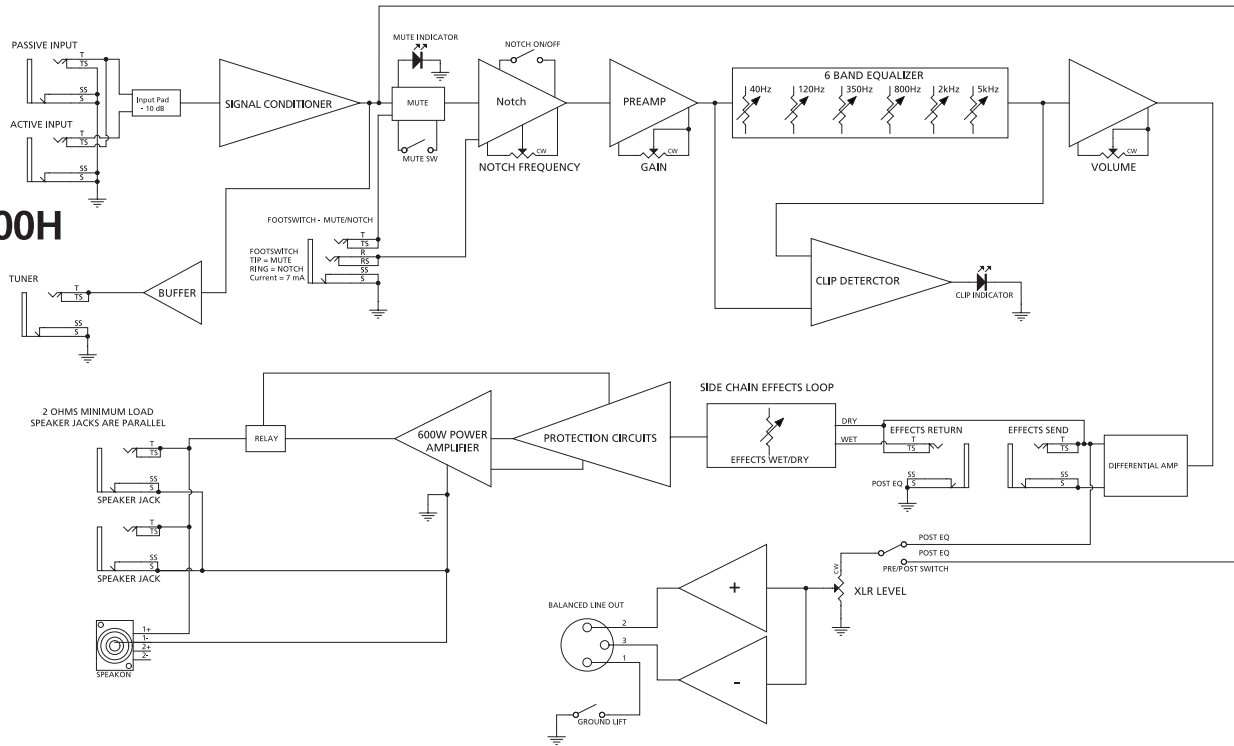

B200, B200H, B410, B115, B600H, B810 USER'S MANUAL

200 WATT COMBO, 200 WATT HEAD, 410 CABINET,
115 CABINET, 600 WATT HEAD, 810 CABINET

www.acousticamplification.com

acoustic[®]

Acoustic Amplification
13659 Victory Boulevard
#1-360
Van Nuys, CA 91401

All trademarks and registered trademarks mentioned herein are recognized as the property of their respective holders.

0808-8192

